

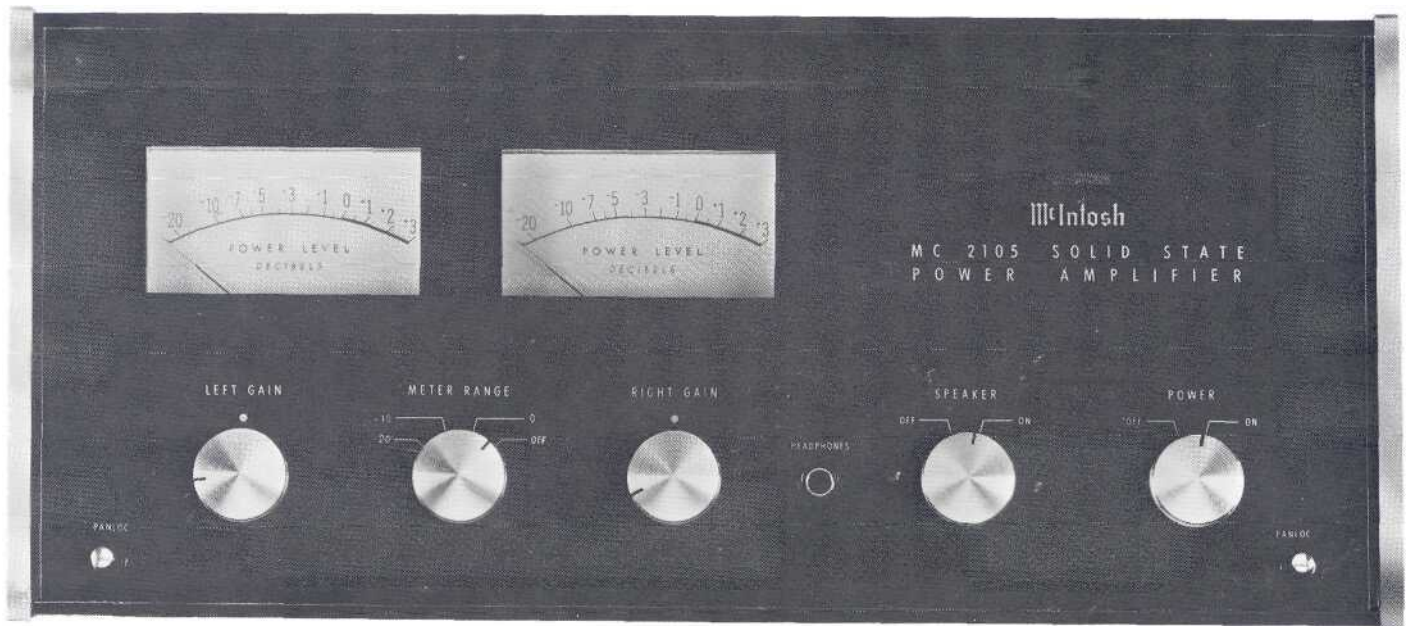

OWNER'S MANUAL

THE MCINTOSH MC 2105 SOLID STATE STEREO POWER AMPLIFIER



Your MC 2105 Stereo Power Amplifier will give you many years of pleasant and satisfactory performance. If you have any questions, please contact:

CUSTOMER SERVICE

McIntosh Laboratory Inc.
2 Chambers Street
Binghamton, New York 13903
Phone: 607-723-3512

WARNING: TO PREVENT FIRE OR SHOCK HAZARD, DO NOT EXPOSE THIS UNIT TO RAIN OR MOISTURE.

**Take Advantage of 3 years
of FREE Factory Service . . .
Fill in the Application NOW.**

CONTENTS

SERVICE CONTRACT	1
INSTALLATION	2,3
HOW TO CONNECT	4,5
HOW TO USE THE DYNAMIC PEAK LOCKING METERS ...	6
FRONT PANEL INFORMATION ...	8
PERFORMANCE LIMITS AND RATINGS	9
TYPICAL PERFORMANCE CHARTS ..	10
TECHNICAL DESCRIPTION	11
BLOCK DIAGRAM	12

THREE YEAR FACTORY SERVICE CONTRACT

An application for a FREE THREE YEAR FACTORY SERVICE CONTRACT is included with this manual.

The terms of the contract are:

1. McIntosh will provide all parts, materials and labor needed to return the measured performance of the instrument to the original performance limits free of any charge. The SERVICE CONTRACT does not cover any shipping costs to and from the authorized service agency or the factory.
2. Any McIntosh authorized service agency will repair all McIntosh instruments at normal service rates. To receive the free service under the terms of the SERVICE CONTRACT, the SERVICE CONTRACT CERTIFICATE must accompany the instrument when taken to the service agency.
3. Always have service done by a McIntosh authorized service agency. If the instrument is modified or damaged, as a result of unauthorized repair the SERVICE CONTRACT will be cancelled. Damage by improper use or mishandling is not covered by the SERVICE CONTRACT.
4. The SERVICE CONTRACT is issued to you as the original purchaser. To protect you from misrepresentation this contract cannot be transferred to a second owner.
5. For your protection McIntosh selects its dealers carefully. Only one dealer in ten qualifies for a McIntosh franchise. To receive the SERVICE CONTRACT your purchase must be made from a McIntosh franchised dealer.
6. Your completely filled in application for a SERVICE CONTRACT must be postmarked within 30 days of the date of purchase of the instrument.
7. To receive the SERVICE CONTRACT all information on the application must be filled in. The SERVICE CONTRACT will be issued when the completely filled in application is received at McIntosh Laboratory Incorporated in Binghamton, New York.

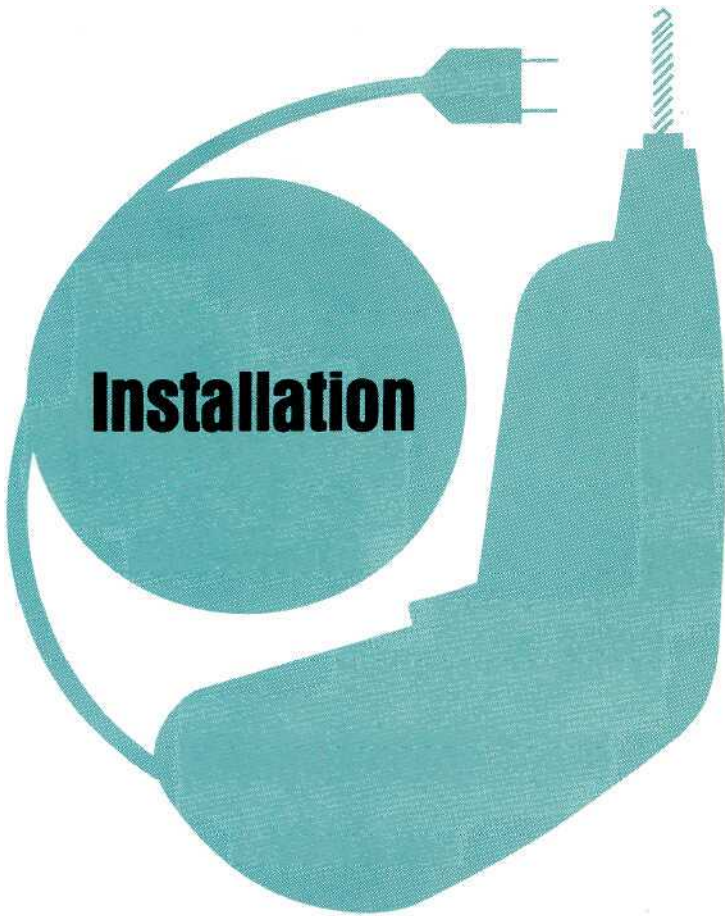

Adequate ventilation extends the trouble-free life of electronic instruments. It is generally found that each 10° centigrade (18° F) rise in temperature reduces the life of electrical insulation by one half. Adequate ventilation is an inexpensive and effective means of preventing insulation breakdown that results from unnecessarily high operating temperatures. The direct benefit of adequate ventilation is longer, trouble-free life.

Allow at least 15 inches deep x 17 inches wide x 8 inches high for mounting the MC2105. Always allow for air flow by either ventilation holes or space next to the bottom of the amplifier and a means for a warm air to escape at the top. With adequate ventilation the amplifier can be mounted in any position.

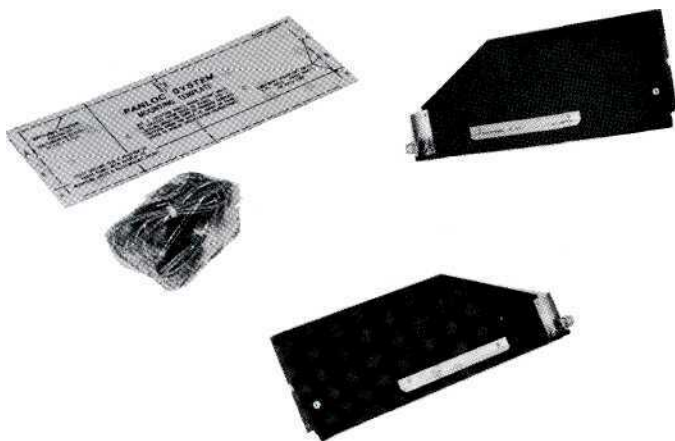

To prepare the MC 2105 for installation remove the plastic protective covering. Turn it upside down so that it rests on its top on the shipping pallet. Remove the four plastic feet fastened to the bottom of the chassis.

Next, place the mounting brackets, the parts bag and the mounting template at hand.

The PANLOC professional mounting design eliminates the need for any shelf or bracket to support the MC 2105. It is completely supported by its own mounting brackets.

The design of the mounting template allows you to position or locate the cutout from the front or rear of the panel to which the instrument is to be mounted. Position the plastic mounting template over the area of the panel to be cut out for installation.

If the cutout is to be located from the front of the panel, begin at 2. If the cutout is to be located from the rear of the panel, begin here.

1. On the back of the cabinet panel, scribe a vertical centerline through the exact center of the area in which the cutout is to be made.

Place the template against the back of the panel and match the template centerline with the centerline on the cabinet panel.

Make sure that there is at least ¼ inch clearance between the bottom of the dashed line of the cutout area on the template and any shelf or brace below the proposed cutout.

Mark the two locating holes ("C" holes on the mounting template).

Drill the two locating holes. Be certain the drill is perpendicular to the panel.

Now position the template on the front of the panel by aligning the "C" locating holes on the template with the drill holes.

2. If the cutout is to be located from the front of the panel:

With the template in place against the cabinet panel, mark the "A" and "B" drill holes and the four small holes that identify the corners of the cutout. Join the corner marks with a pencil. The edge of the template can be used as a straight edge.

IMPORTANT: DRILL THE 6 HOLES BEFORE MAKING THE CUTOUT.

Accurately drill the three holes on each side of the cutout area with a 3/16 inch drill.

With the saw on the **INSIDE OF THE PENCIL LINES** carefully cut out the rectangular opening.

Secure the mounting strips to the rear of the cabinet panel using two screws from the hardware package.

Insert the screws in the center holes of the cabinet panel ("B" holes on the template) and tighten. The screw head should pull into the wood slightly. (Use two 5/8 inch long screws for panels under 1/2 inch, or two 1 1/4 inch long screws for panels 1/2 inch thick and larger.)

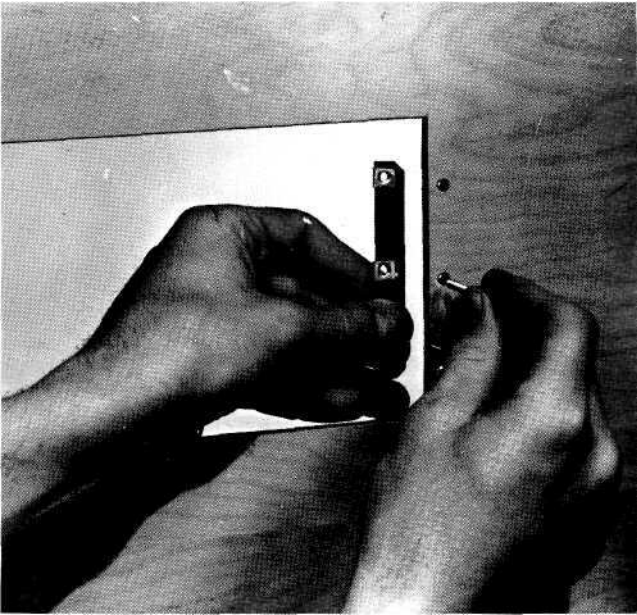

Attach the mounting brackets to the cabinet panel using four screws.

Place the template over the mounting screws. The mounting screws should be centered in the "A" and "B" holes on the template. The sides of the mounting brackets should match the vertical dash lines on the template. If necessary, loosen the screws and push the brackets into alignment and retighten.

Insert the power cord through the opening. Carefully slide the MC 2105 into the opening so the rails on the bottom of the equipment slide in the track of the mounting brackets. Slide the instrument in until it stops at the adjust position latches. Press the latches in and continue to slide the instrument in until the front panel is against the cabinet panel. At the bottom front corners of the PANLOC instruments are the PANLOC buttons. Depressing the PANLOC buttons will lock the instrument firmly in the installation. Depressing the PANLOC buttons a second time (as with a ballpoint pen) will release the instrument. You can then slide the instrument forward to the inspection-adjustment position. Depressing the inspection-adjustment position latches will allow the instrument to be slid completely out of the installation.

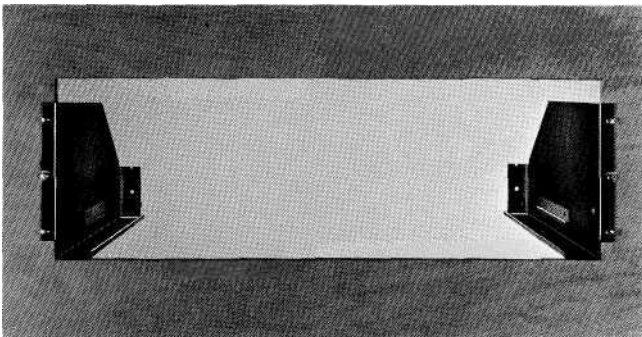

HOW to Connect

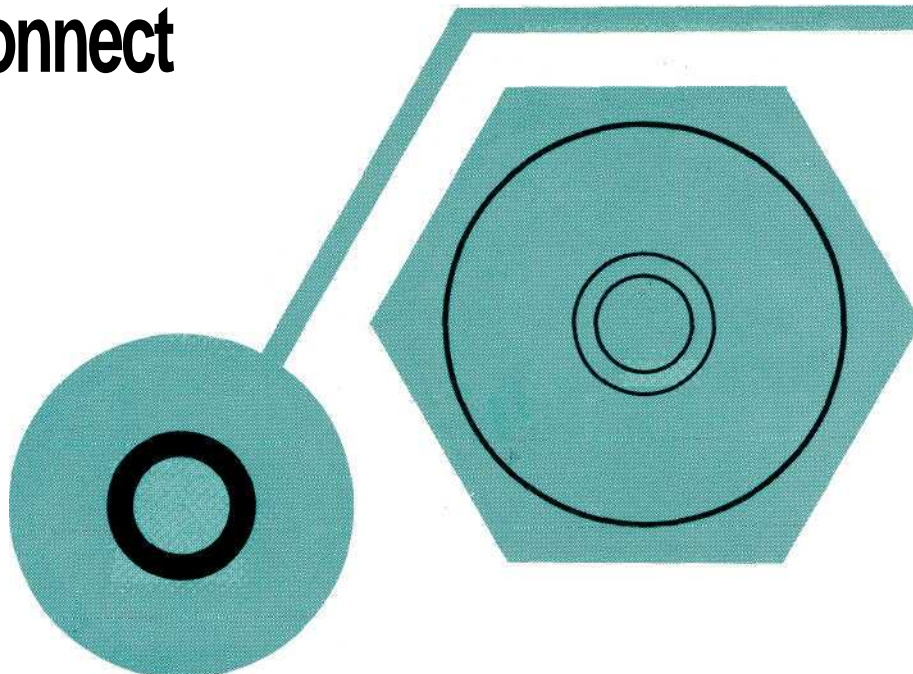

INPUT STEREO

The shielded cable from the left output of the McIntosh preamplifier is plugged into the left jack. The shielded cable from the right output of the McIntosh preamplifier is plugged into the right jack.

SPEAKERS

Speakers are connected at the barrier strips marked OUTPUT on the back panel of the amplifier. Use lamp cord, bell wire, or wire with similar type of insulation to connect the speakers to the amplifier. For the normally short distances of under 50 feet between the amplifier and speaker, #18 wire or larger can be used. For distances over 50 feet between the amplifier and speaker use larger wire.

The loudspeaker impedance is usually identified on the loudspeaker itself. Connect one of the leads from the left loudspeaker to the screw marked COM on the LEFT OUTPUT barrier strip. Connect the other lead from the left loudspeaker to the screw marked with the number corresponding to the speaker impedance on the LEFT OUTPUT barrier strip. Connect one of the leads from the right loudspeaker to the screw marked COM on the RIGHT OUTPUT barrier strip. Connect the other lead from the right loudspeaker to the screw marked with the number corresponding to the speaker impedance on the RIGHT OUTPUT barrier strip.

The only adverse effect on the operation of a McIntosh amplifier when it is improperly matched is a reduction in the amount of distortion-free power available to the loudspeaker. Close impedance matching is desirable for maximum distortion-free power.

SPEAKER CONNECTIONS

Use this table to determine proper speaker connection.

If the speaker impedance is between:	Connect the speaker leads between COM and:
3.2 to 6.5 ohms	4 ohms
6.5 to 13 ohms	8 ohms
13 to 26 ohms	16 ohms

Connect as follows:

If the speaker impedance is:	Connect one left speaker to screw LEFT-COM and other to:	Connect one right speaker lead to the screw marked RIGHT-COM and the other to:
4 ohms	LEFT-4	RIGHT-4
8 ohms	LEFT-8	RIGHT-8
16 ohms	LEFT-16	RIGHT-16

DO NOT CONNECT A MONOPHONIC LOUDSPEAKER TO BOTH TERMINALS. THE LOUDSPEAKER CAN BE DAMAGED.

For 25 volt line operation connect one of the left leads to the screw marked COM on the LEFT OUTPUT barrier strip. The other left lead is connected to the screw marked 8W on the LEFT OUTPUT barrier strip. Connect the right leads in the same manner on the RIGHT OUTPUT barrier strip.

AC POWER:

The MC 2105 operates on 117 to 130 volt, 50/60 Hz. The amplifier will be turned on and off if its power cord is plugged in one of the auxiliary AC power outlets on the program source.

How to Connect

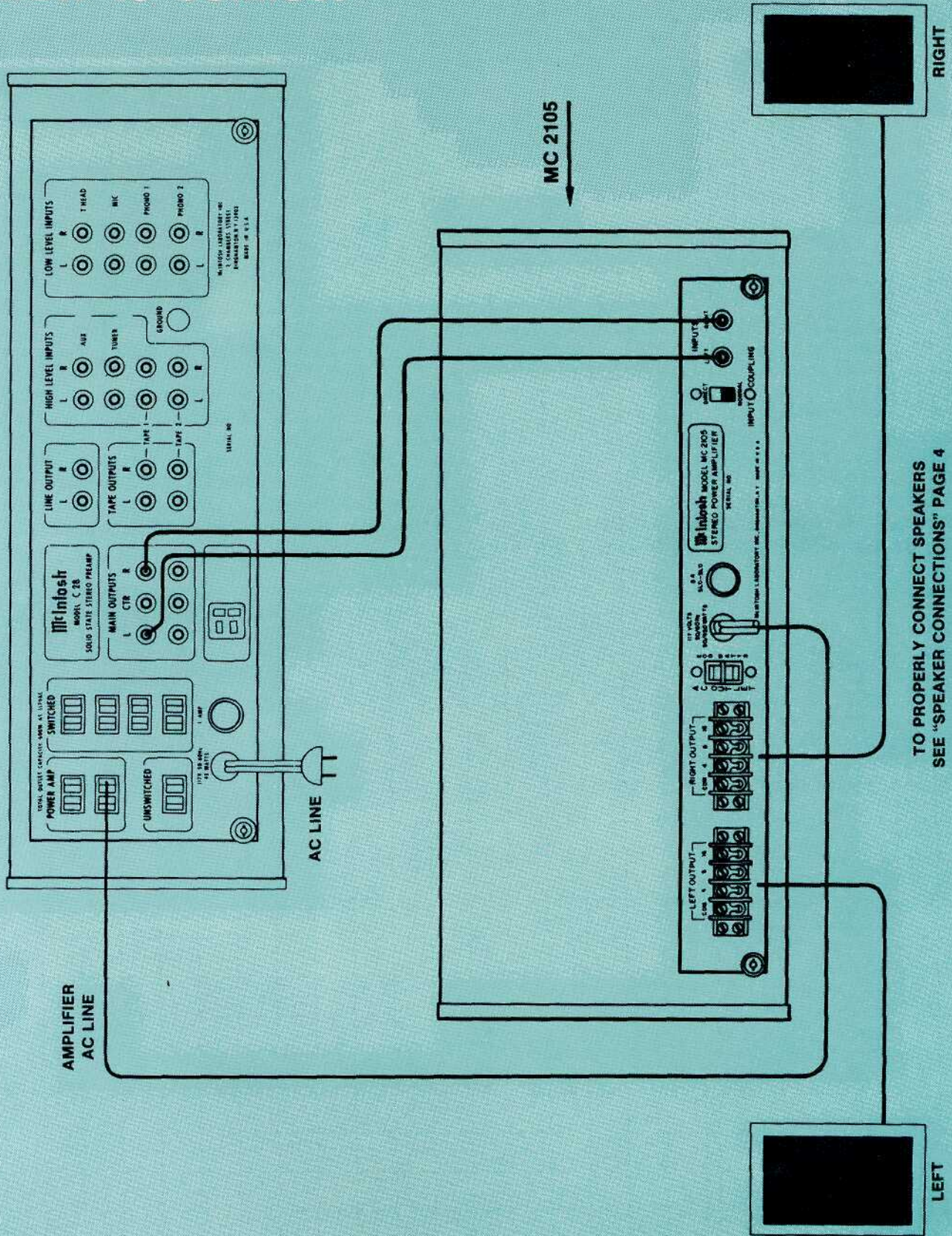

TO PROPERLY CONNECT SPEAKERS
SEE "SPEAKER CONNECTIONS" PAGE 4

HOW to Use the Dynamic Peak Locking Meters

Ordinary meters lack the capability of indicating the short interval power in a sound wave. The mass of the meter movement is too great to respond to instantaneous changes in music program material. McIntosh superior engineering has developed new circuitry that permits the meters on the MC 2105 to respond to the short interval power in a sound wave to an accuracy of 98% of the true value. This is another McIntosh development that represents a major step forward in the use of power level meters.

There are two circuits that give these meters the indicating capability of the short interval power in a sound wave. The first circuit is an accelerating circuit that compensates for the inertia characteristics of the meter movement. Because the short interval power fluctuation is so rapid, the eye might not perceive the instantaneous power reading. This caused the development of the second circuit, which is a "time stretching" circuit. The time stretching circuit delays the movement of the meter needle at peak reading for a few milliseconds.

With the aid of the CBS test record STR1000 the frequency response of your phono cartridge can be measured. The graph on page 7 shows the ideal RIAA curve using the CBS record STR100.

Follow these steps to plot the performance of your phonograph cartridge.

1. Set the "METER RANGE SWITCH" to the -20 position.
2. Play the 1000 Hz test tone recorded on the CBS Test Record STR100 on your phonograph.
3. Turn the LEFT GAIN control until the left meter indicates "0."
4. Turn the RIGHT GAIN control until the right meter indicates "0."
5. Write down the meter indication at each frequency as the record plays.
6. Transfer the readings by frequency to the graph.
7. The graph shows the ideal RIAA response curve using the CBS STR1000 test record. Compare your curve with the curve on the graph. A deviation of 3 dB from the ideal is acceptable. By making this check at regular intervals, (for instance, every 6 months) any deterioration in the cartridge or system will be quickly detected.

A tape recorder can be checked in the same fashion.

1. Use a standard frequency response tape as the signal source.
2. Complete all steps outlined for phono cartridges.
3. You now have a graph of the playback characteristics of your tape recorder.

To find the record characteristics of the tape recorder follow this procedure:

1. Record the CBS Test Record STR1000 on your tape recorder. Adjust the record volume only on the 1000 Hz signal for proper recording level. **DO NOT ADJUST THE RECORD VOLUME CONTROL DURING THE RECORDING.**
2. Play back the tape just recorded. Complete all steps outlined for tape playback characteristics.
3. A comparison of the two curves will give the recording characteristics of your tape recorder. A deviation of 3 dB is acceptable.

Similar checks can be made on all program sources in your stereo system. Follow the same general procedure for any program source for which a standard reference is available.

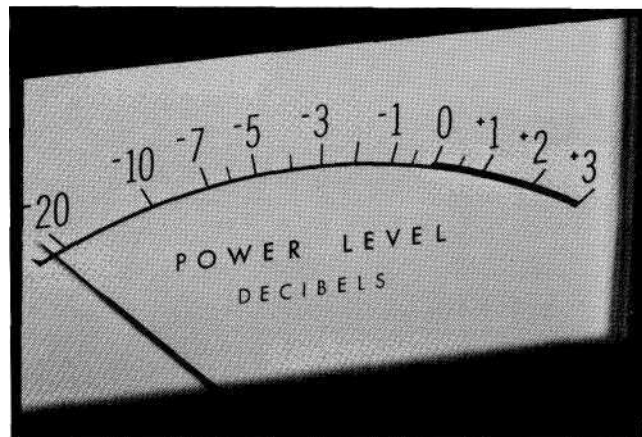
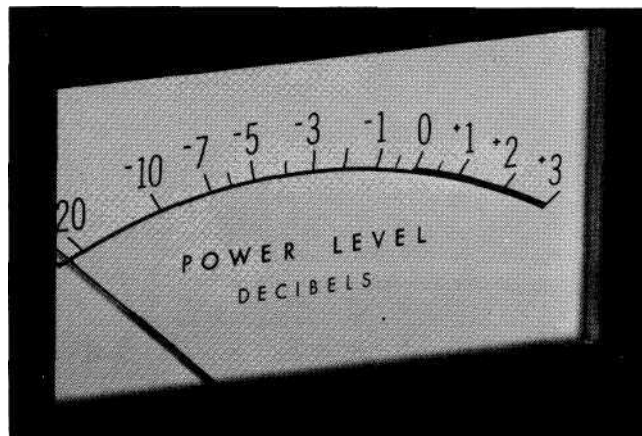

IDEAL RIAA SYSTEM RESPONSE USING CBS STR 100 TEST RECORD

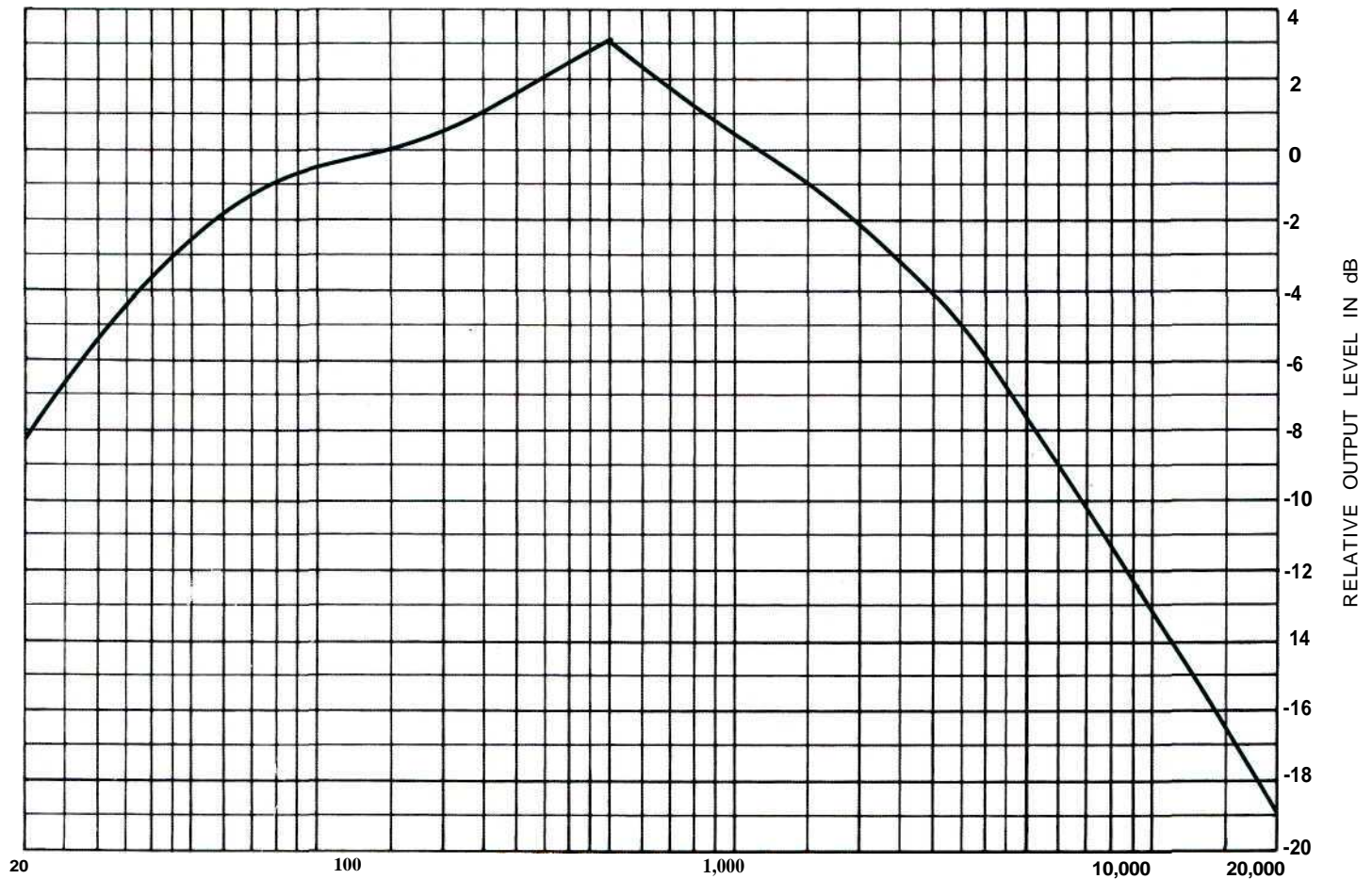
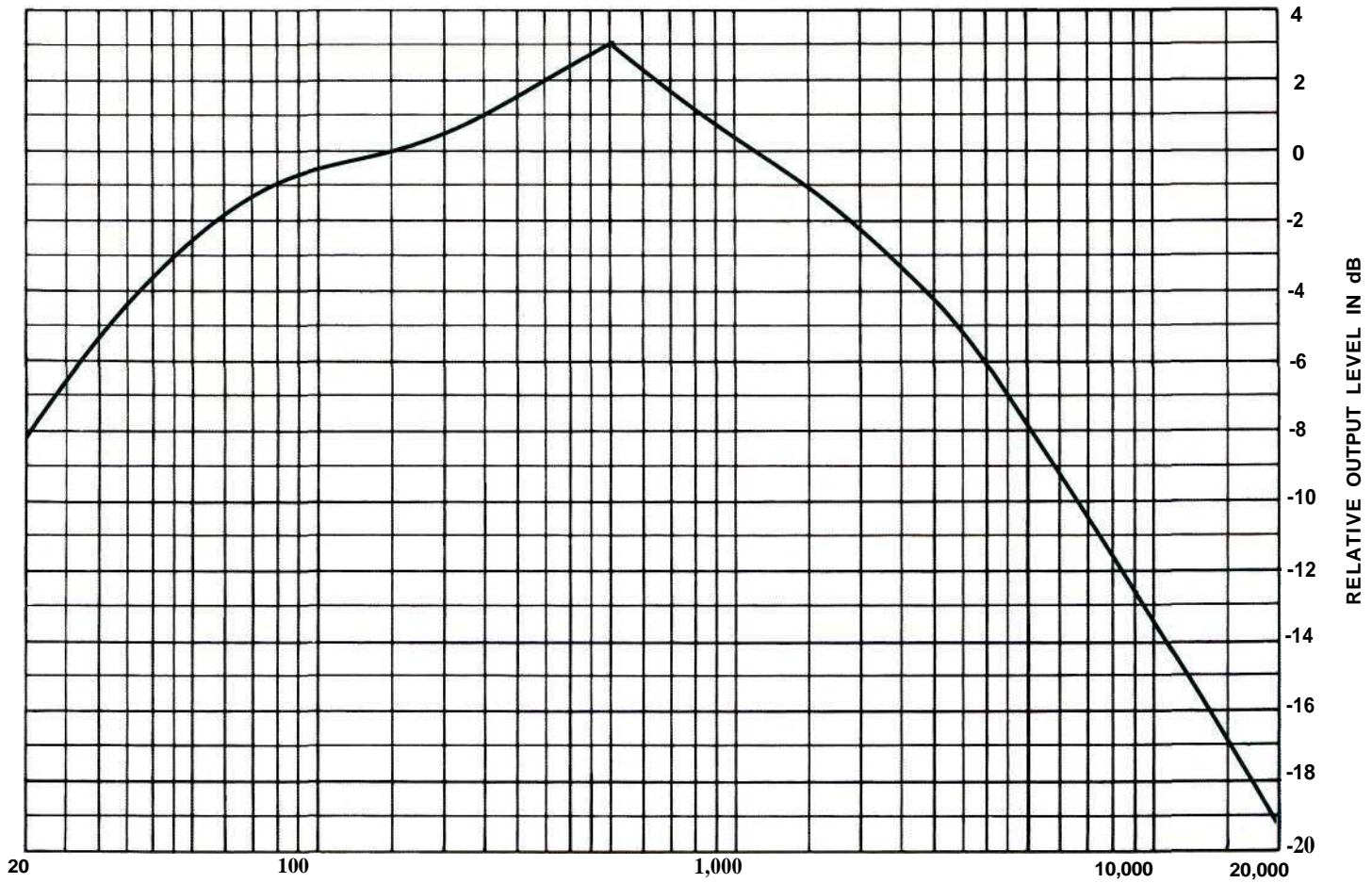

FREQUENCY IN Hz

Front Panel information

LEFT GAIN

Use the left gain control to adjust the volume in the left channel to the desired listening level. Turn the control clockwise to increase the volume.

RIGHT GAIN

Use the right gain control to adjust the volume in the right channel to the desired listening level. Turn the control clockwise to increase the volume.

METER RANGE

The meter switch has four positions. The first position is OFF. With the switch in the OFF position there is no indication on the meters.

-0 In this position of the meter range switch, the amplifier will deliver 100 watts when the meter indicates +3dB, with meter indication of "0", the amplifier delivers 50 watts, with a meter indication of -3dB,

-10 In this position of the meter range switch, the amplifier will deliver 5 watts output when the meter indicates "0". With a meter indication of -3dB, the amplifier delivers 2½ watts output and a -10dB meter indication, the amplifier delivers ½ watt.

-20 In this position of the meter range switch, the amplifier will deliver ½ watt (500 milliwatts) when the meter indicates "0". With a meter indication of -3dB, the amplifier delivers ¼ watt (250 milliwatts) and a -10dB meter indication the amplifier delivers 50 milliwatts.

the amplifier delivers 25 watts; and a meter indication of -10dB, the amplifier delivers 5 watts.

(A meter reading of +3.2dB indicates 105 watts power output.)

HEADPHONE

Use the jack for low impedance stereo headphones. The headphone jack is on at all times.

SPEAKERS

OFF: The loudspeakers are turned off when the SPEAKER switch is in the OFF position. You can listen to headphones in private.

THIS SWITCH MUST BE IN THE "ON" POSITION TO HEAR MUSIC FROM THE LOUDSPEAKERS.

ON: Music will be heard through the loudspeakers. Use this as the normal listening position.

POWER

The power switch turns the MC2105 on or off. The switch does not control the power outlet on the back panel. If you wish to control the operation of the on/off switch from a preamplifier control center leave the switch in the ON position. In this case be sure to plug the AC cord of the MC 2105 into the controlled outlets on the rear of the preamplifier control center.

OFF: In the OFF position the AC to the amplifier is turned off.



Performance Limits and Ratings

PERFORMANCE GUARANTEE

Performance Limits are the maximum deviation from perfection permitted for a McIntosh instrument. We promise you that the MC 2105 you buy must be capable of performance at or exceeding these limits or you get your money back. McIntosh is the only manufacturer that make this guarantee.

PERFORMANCE

McIntosh audio power ratings are in accordance with the Federal Trade Commission Regulation of November 4, 1974 concerning power output claims for amplifiers used in home entertainment products,

POWER OUTPUT

105 watts minimum sine wave continuous average power output, per channel, both channels operating into 4 ohms, 8 ohms, or 16 ohms load impedance, which is:

- 20.5 volts RMS across 4 ohms
- 29.0 volts RMS across 8 ohms
- 41.0 volts RMS across 16 ohms

OUTPUT LOAD IMPEDANCE

4 ohms, 8 ohms, or 16 ohms; separate terminals are provided for each output

RATED POWER BAND

20 Hz to 20,000 Hz

TOTAL HARMONIC DISTORTION

0.25% maximum harmonic distortion at any power level from 250 milliwatts to 105 watts per channel from 20 Hz to 20,000 Hz, both channels operating

INTERMODULATION DISTORTION

0.25% if instantaneous peak power output is 210 watts or less per channel with both channels operating for any combination of frequencies 20 Hz to 20,000 Hz

FREQUENCY RESPONSE

20 Hz to 20,000 Hz +0 -0.25 dB
10 Hz to 100,000 Hz +0 -3.0 dB at one watt output

NOISE AND HUM

90 dB below rated output

OUTPUT POWER MONITOR METER

Meter is calibrated to read +3 dB when amplifier produces 105 watts. Meter range switch is provided to increase meter sensitivity by 10 dB or 20 dB. Calibration accuracy at 0 dB reading is $\pm 2\%$ at all frequencies; meter range accuracy is $\pm 5\%$

RATINGS

OUTPUT VOLTAGES

25 volts for distribution lines

DAMPING FACTOR

13 at 8 ohms output
18 at 4 ohms output
10 at 16 ohms output

INPUT IMPEDANCE

200.00 ohms

INPUT SENSITIVITY

0.5 volt. Level control provided for higher input voltage

GENERAL INFORMATION

POWER REQUIREMENTS

120 volts 50 60 Hz, 75 watts at zero signal output, 430 watts at rated output

SEMICONDUCTOR COMPLEMENT

34 silicon transistors
18 silicon rectifiers and diodes

MECHANICAL INFORMATION

SIZE

Front panel measures 16 3/16 inches wide (41.12 cm) by 7 1/8 inches high (18.1 cm). Chassis measures 15 inches wide (38.1 cm) by 6 9/16 inches high (16.67 cm) by 14 1/2 inches deep (36.83 cm), including connectors. Knob clearance required is 1 1/2 inches (3.81 cm) in front of mounting panel

FINISH

Front panel is anodized gold and black with special gold teal nomenclature illumination. Chassis is chrome and black

MOUNTING

Exclusive McIntosh developed professional PANLOC

WEIGHT

65 pounds (29.48 kg) net, 77 pounds (34.93 kg) in shipping carton

SPECIAL FEATURES

The amplifier is completely stable when connected to any loudspeaker system or even to any reactive loads; The MC 2105 has special circuits to prevent damage by short circuit or open circuit of the output loads, or by any amount of output impedance mismatch, Thermal cutouts are mounted on the output transistor heat sinks to provide protection in the event of inadequate ventilation.

Peak reading - peak locking meters feature special circuit to respond to peak value of complex input signal.

TYPICAL PERFORMANCE CHARTS

PER CHANNEL
BOTH CHANNELS
OPERATING

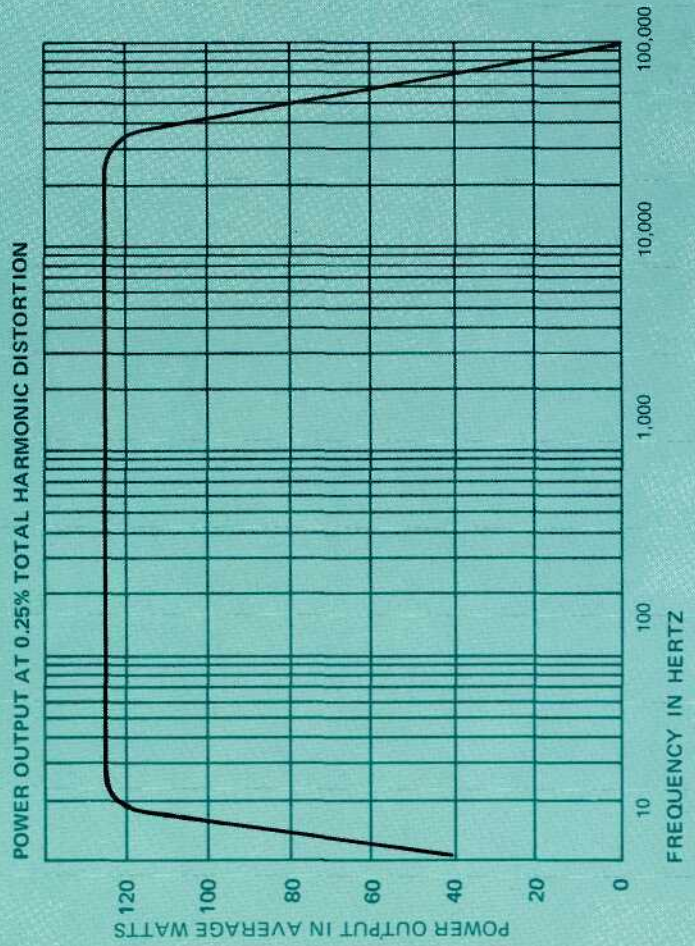
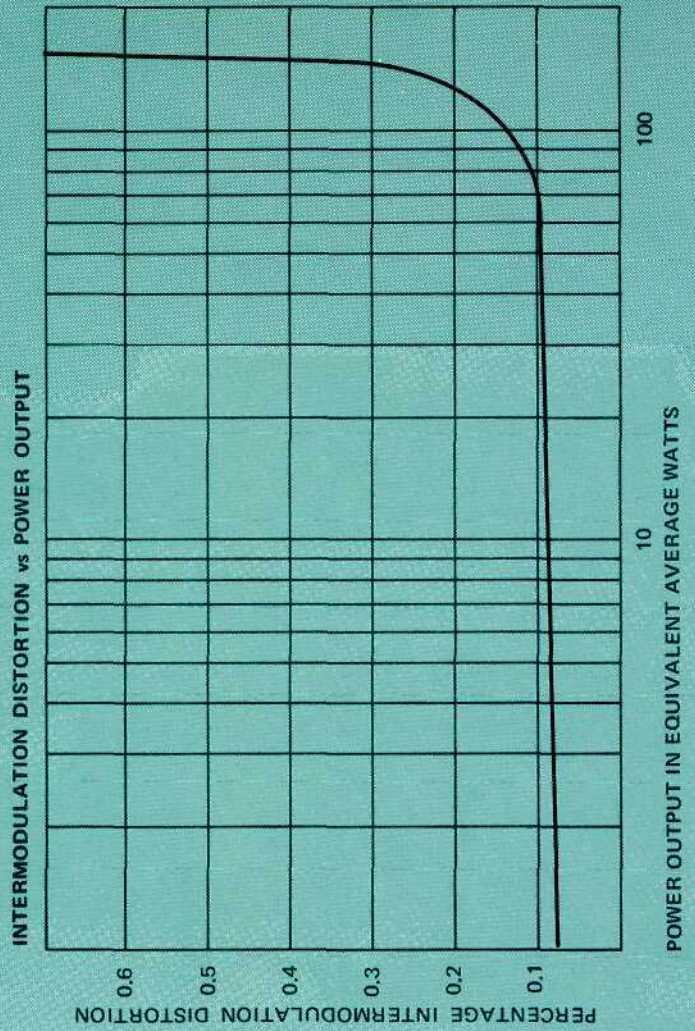
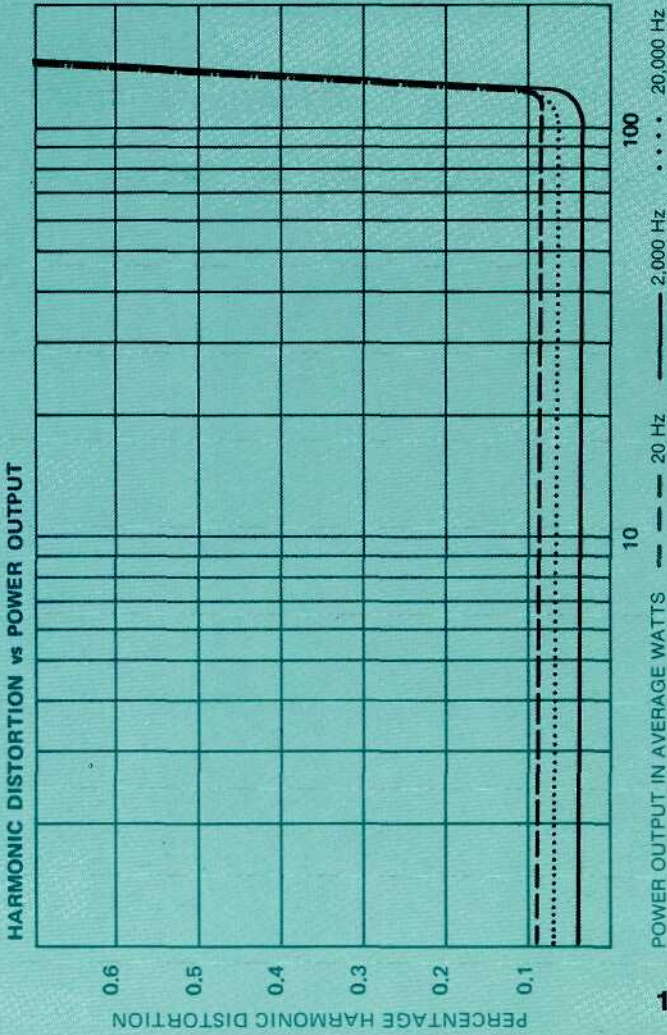
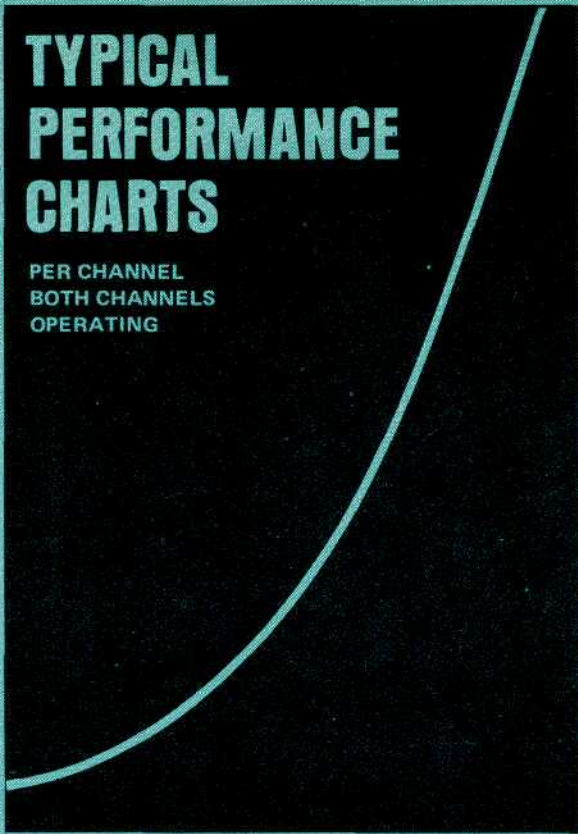

Technical Description

A two stage amplifier with three transistors in each channel increases the input voltage 16 dB.

There are 13 transistors in each power amplifier section. The two stage preamplifier is fed to a pair of matched transistors arranged as an emitter coupled amplifier with two inputs and one output. The signal from the preamplifier section connects to one of these inputs. Both AC and DC negative feedback are applied to the other input. This large quantity of feedback is used to reduce noise and distortion. The signal is then fed to a voltage amplifier. The voltage amplifier is followed by two driver transistors.

The output section is arranged as a series push-pull amplifier. The power transistors used in the output section of your MC 2105 are selected for their high power dissipation capability, wide frequency response, and large "safe operating area." In addition, each power transistor is given four separate tests before it is put in your MC 2105. This additional testing makes sure your MC 2105 will deliver its rated power from 20 to 20 kHz with low distortion and complete reliability.

The power transistors are mounted on oversized anodized heat sinks. The heat sinks assure that under normal operation the transistors will operate at a low temperature. If temperatures increase due to a shorted speaker, or restricted ventilation, an automatic temperature sensing device turns off the MC 2105. The device operates automatically at a preset temperature. The MC 2105 will turn on again when the temperature has returned to normal limits. This additional feature gives your MC 2105 complete reliability under the most extreme operating conditions.

The output stages are matched to the load by the McIntosh autoformer. The McIntosh autoformer is carefully wound using McIntosh trifilar winding and interleaving techniques. Trifilar winding and interleaving gives the transformers exceptional bandwidth. The autoformers properly match the power transistors to 4, 8, and 16 ohm loads at all audio frequencies.

The use of the McIntosh designed trifilar autoformer makes the McIntosh solid state amplifiers the only amplifiers that deliver FULL POWER AT ALL SPEAKER IMPEDANCES. You have not been power penalized for your choice of loudspeakers when using the McIntosh MC 2105.

Another of the advantages of the autoformers is the 25 volt output for a constant voltage distribution system. With the MC 2105 several sets of speakers can be operated independently throughout your home.

To further insure reliability a special power output SENTRY MONITORING CIRCUIT prevents failure of the power output transistors due to exces-

sive mismatch of the output. When your MC 2105 operates normally the SENTRY MONITORING CIRCUIT has no effect on signals passing through the power amplifier. If the power dissipation should rise above normal operation, the SENTRY MONITORING CIRCUIT restricts the drive to the output transistors. The SENTRY MONITORING CIRCUIT acts instantaneously for any input signal or load combination. This arrangement assures complete circuit reliability. Only McIntosh gives you this degree of protection.

POWER SUPPLY SECTION

There are three separate power supply sections. One positive and one negative high current supply is used for the output stages. The other positive supply is used for the driving amplifier stages. All supplies are full wave and use silicon rectifiers. Adequate filtering is used to assure an absolute minimum of hum. The power output stage filter capacitors have very high capacity, which allows full power output below 20 Hz. The power transformer is generous in size and runs cool, even under heavy use.

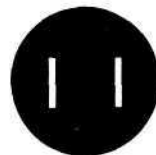
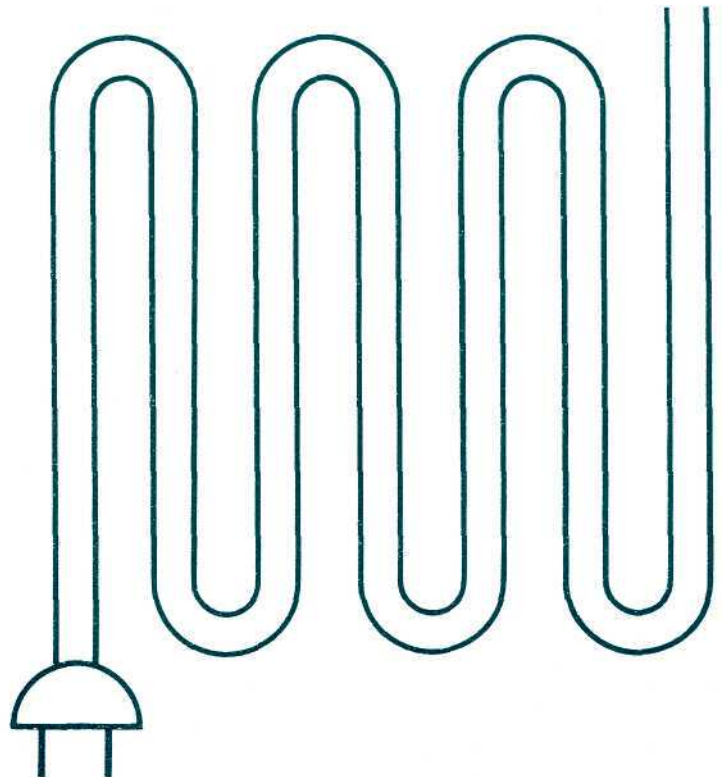

Block Diagram

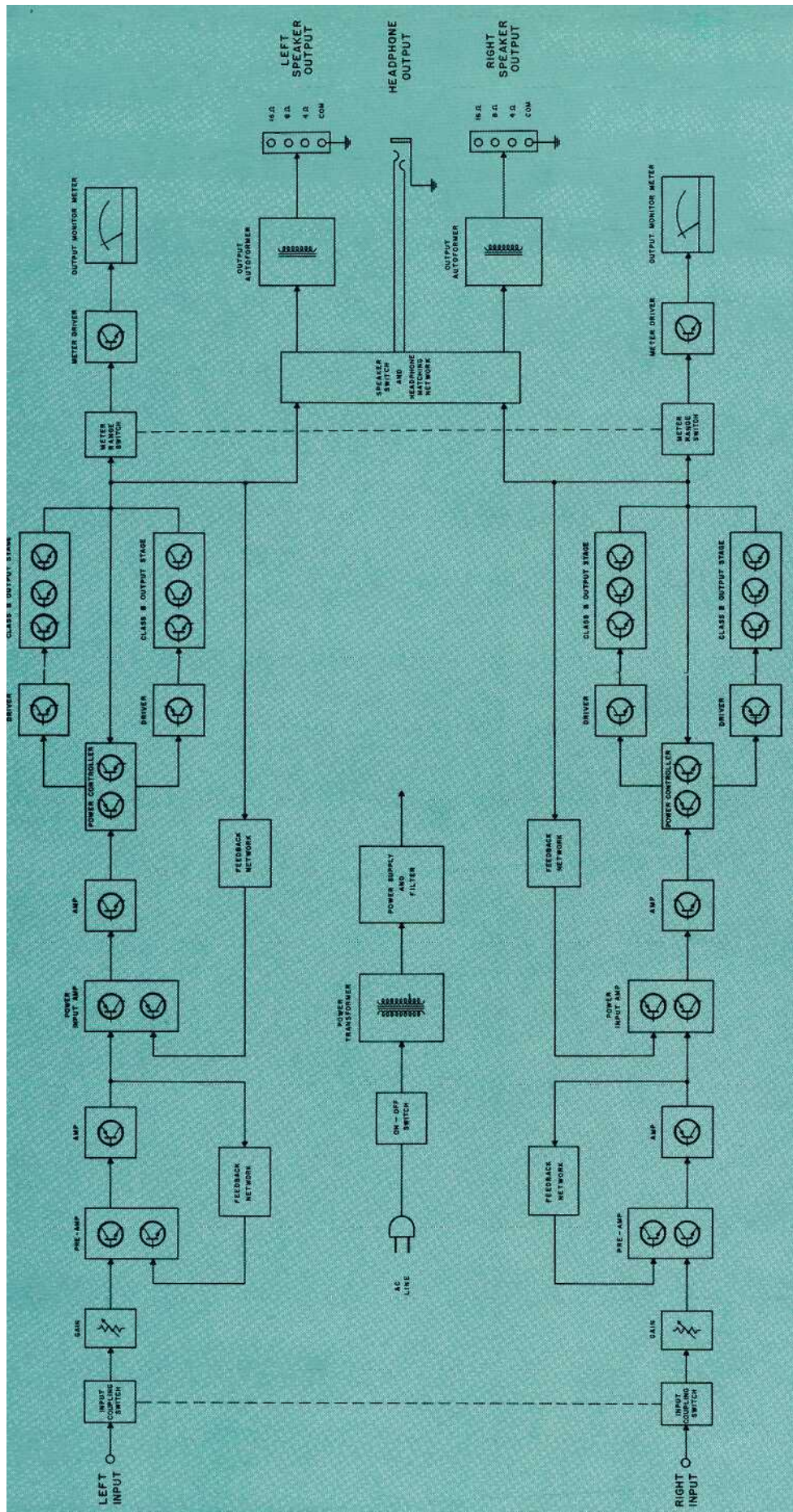

McIntosh

MCINTOSH LABORATORY INC.
2 CHAMBERS ST., BINGHAMTON, N. Y. 13903

607-723-3512

Design subject to change without notice.

Printed in U.S.A.

038-799